

For reference only. See data sheet for the detailed specifications.

Technical Specification

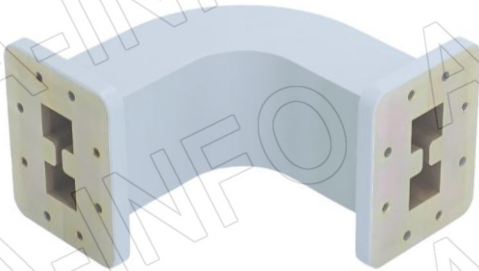

EIA WRD	WRD250
Frequency Range(GHz)	2.6 – 7.8
Insertion Loss(dB)	0.2 Max.
VSWR	1.20:1 Max.
Flange	FPWRD250D30
Material	Al
Size(mm)	131 x 131 x 81
Net Weight(Kg)	0.81 Around

Outline Drawing (Size: mm)

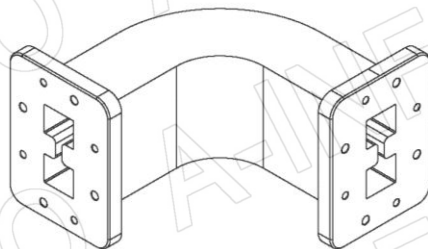
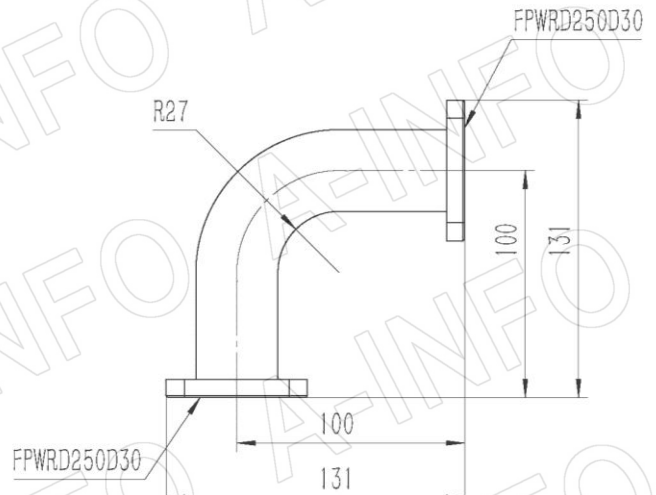
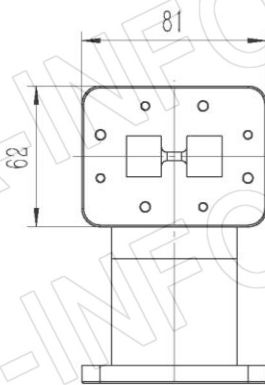

Flange Drawing (Size: mm)

FPWRD250D30

(With four through mounting holes
and four screws holes)

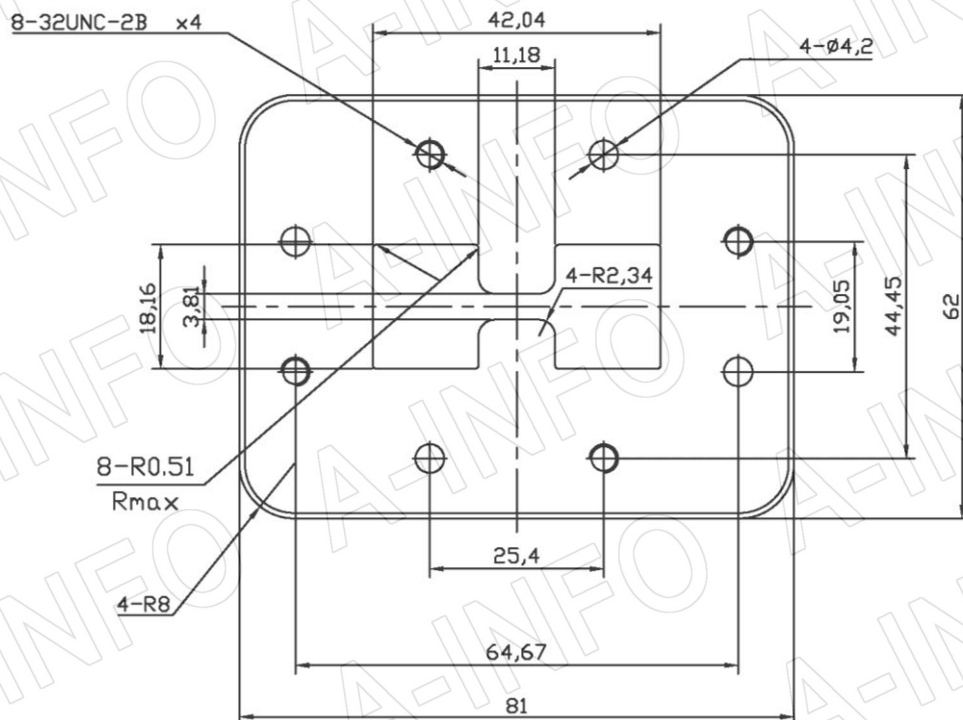
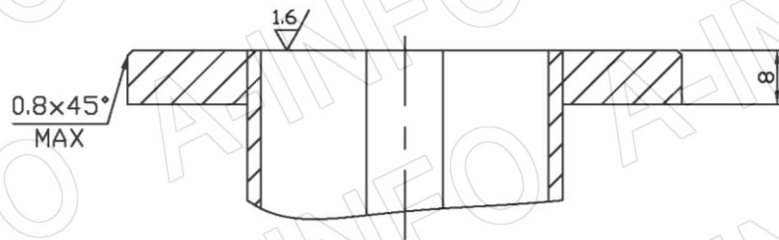

Test Results

I.L.

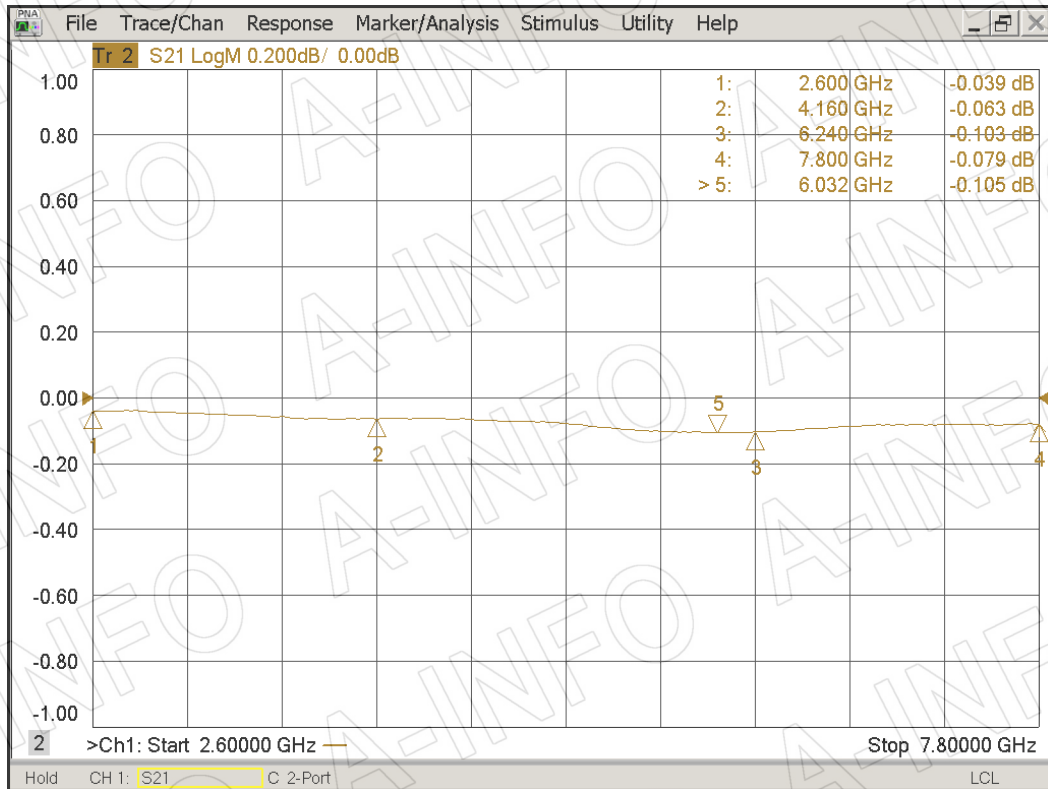

VSWR

